

Data Sheet



Article number: 12620000180710

Description: Threaded pin 620 000 180.710
For M18

Measures

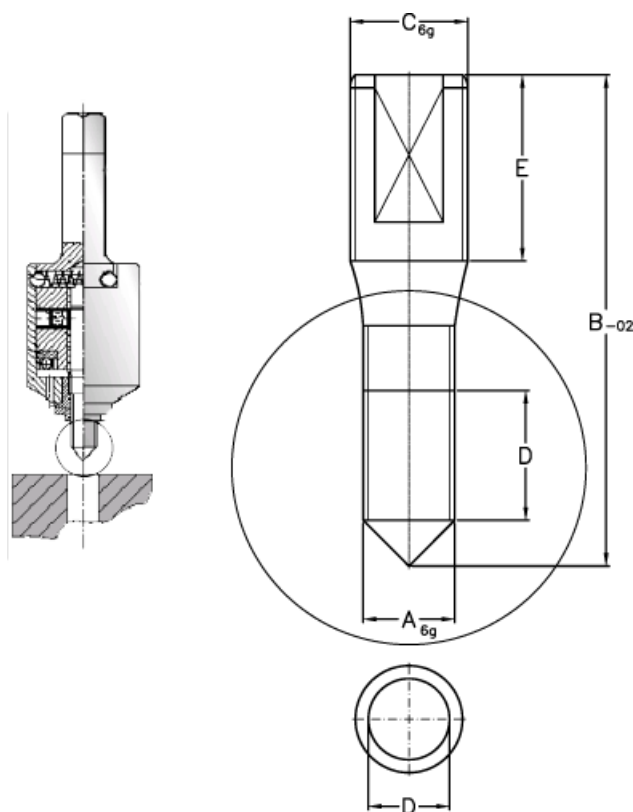

A = M18

B = 92.0

C = M18

D = 36.0

E = 32